

Auxiliary Heater B3LC/D3LC,

from September 1998

Deviate relay location and fuseplacements as well as the locations of multiple connectors see section "component locations".

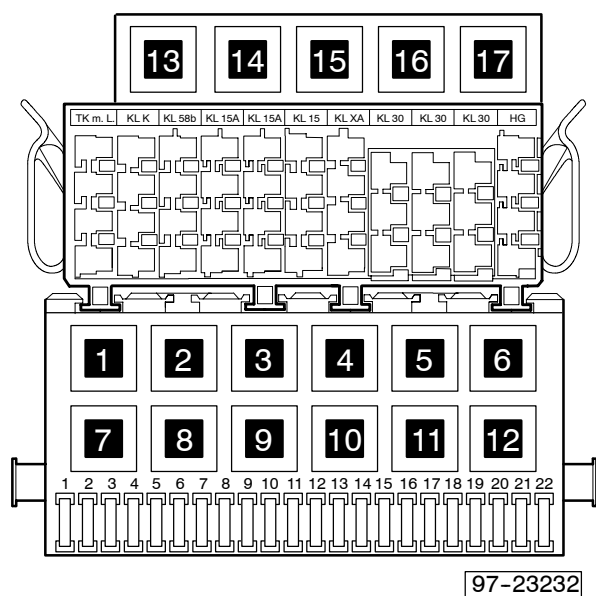

Fuse colors

- 30 A - green
- 25 A - white
- 20 A - yellow
- 15 A - blue
- 10 A - red
- 7,5 A - brown
- 5 A - beige
- 3 A - violet

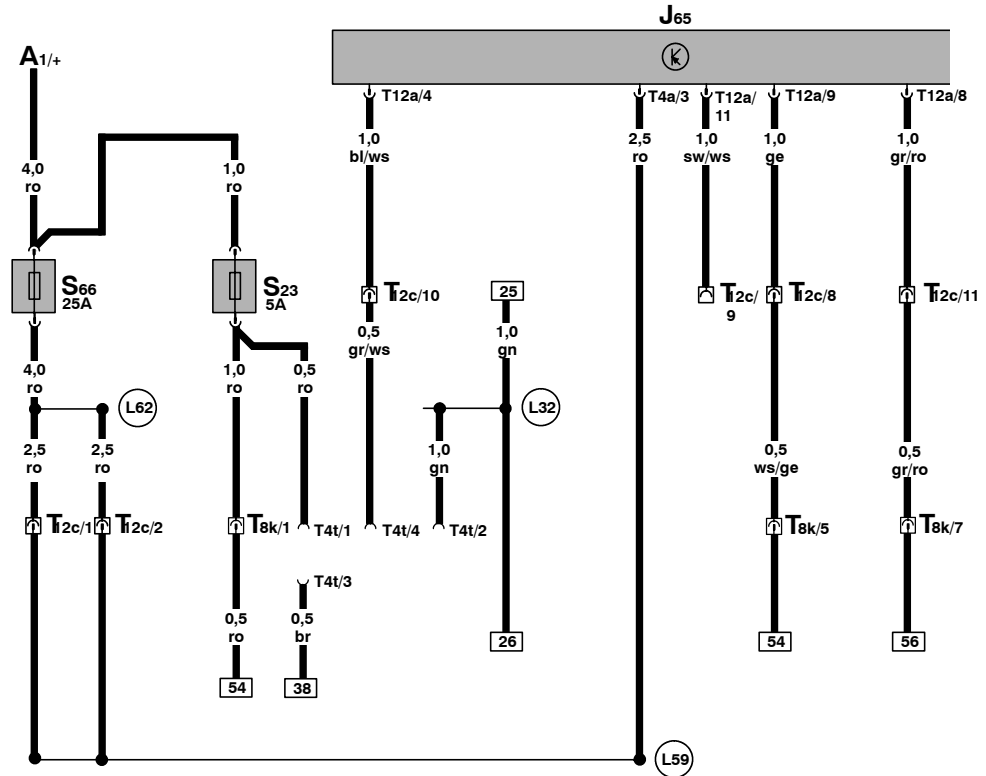
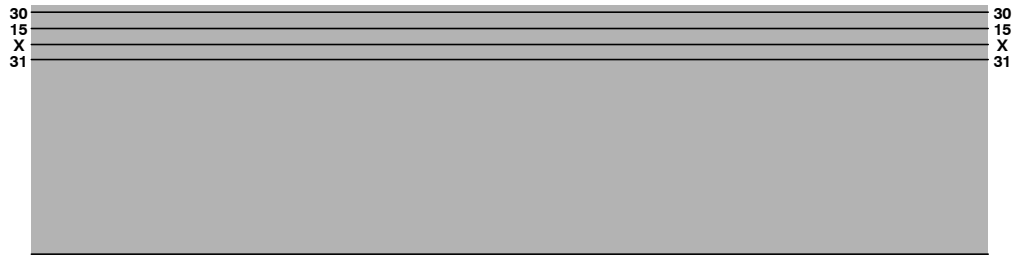

ws = white
 sw = black
 ro = red
 br = brown
 gn = green
 bl = blue
 gr = grey
 li = violet
 ge = yellow

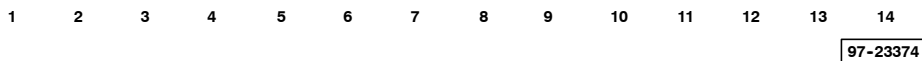

- A1 - Auxiliary Battery, below driver's seat
- J65 - Heater Control Modul, in intake channel
- S23 - Heater Fuse, below driver's seat
- S66 - Auxiliary Heater Glow Plug Fuse, below driver's seat
- T4a - 4-Pin Connector
- T4t - 4-Pin Connector, below driver's seat, data link Connection
- T8k - 8-Pin Connector, below driver's seat
- T12a - 12-Pin Connector
- T12c - 12-Pin Conenctor, to intake channel

(L62) - Plus connector (30a), in wiring harness auxiliary heater

- (L32) - Wire connection -1-, in heater wiring harness
- (L59) - Plus connector (30) in wiring harness heater

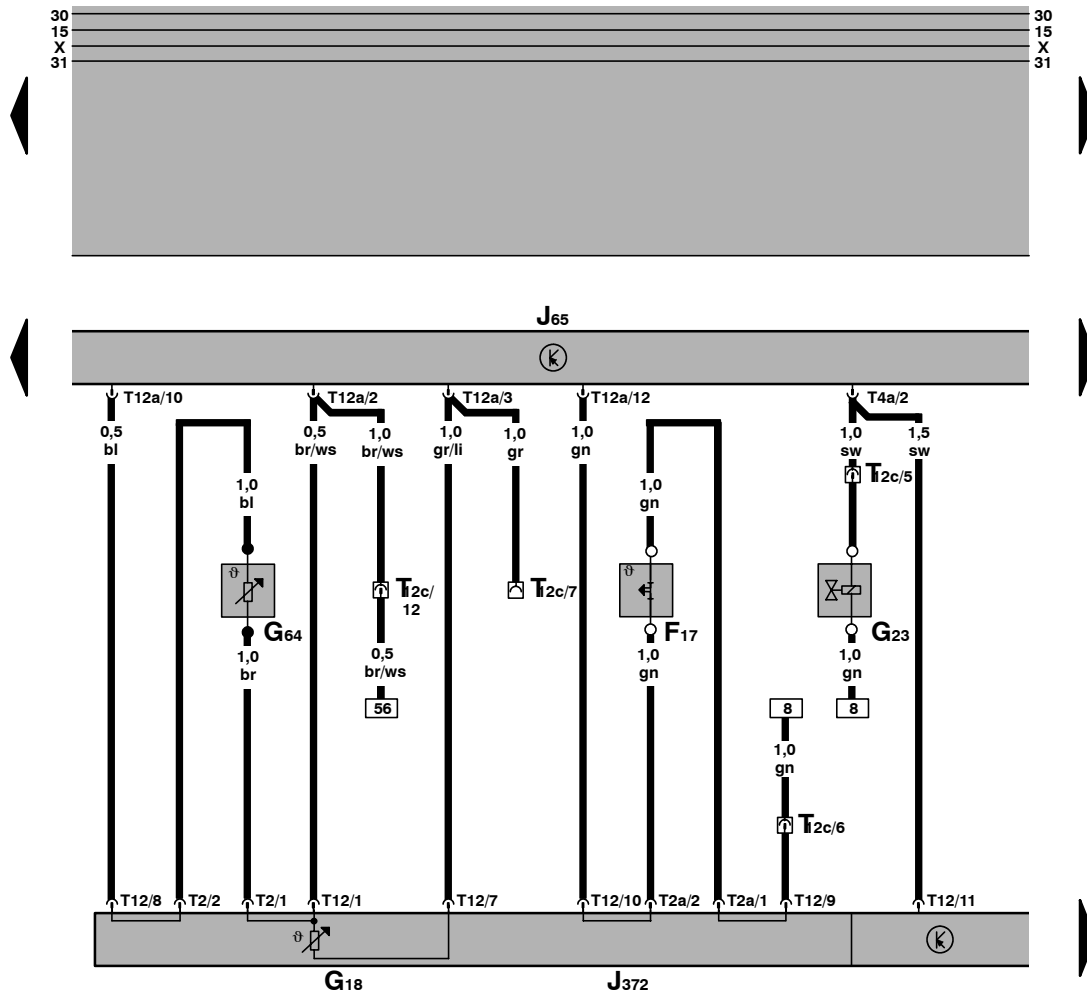

ws = white
 sw = black
 ro = red
 br = brown
 gn = green
 bl = blue
 gr = grey
 li = violet
 ge = yellow

15 16 17 18 19 20 21 22 23 24 25 26 27 28
 97-23375

- F17 - Heater Overheat Control Switch, in heater unit
- G18 - Temperature Sensor II, in heater unit
- G23 - Transfer Fuel Pump (FP)
- G64 - Flame Sensor in heater unit
- J65 - Heater Control Module, in intake channel
- J372 - Circuit board for temperature sensor, control module for blower motor and glow plug
- T2 - Double Connector
- T2a - Double Connector
- T4a - 4-Pin Connector
- T12 - 12-Pin Conenctor
- T12a - 12-Pin Conenctor
- T12c - 12-Pin Conenctor, to intake channel

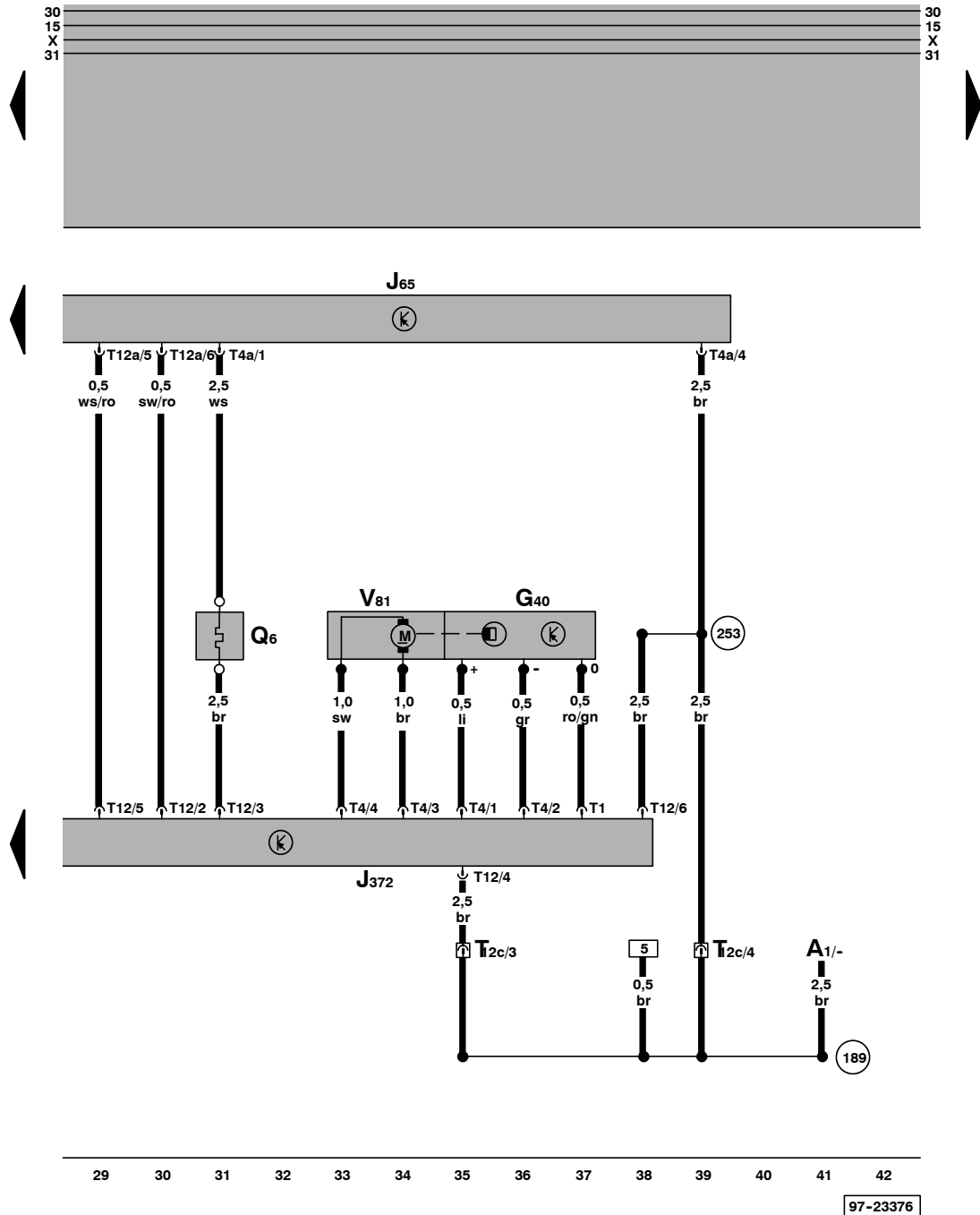

ws = white
 sw = black
 ro = red
 br = brown
 gn = green
 bl = blue
 gr = grey
 li = violet
 ge = yellow

97-23376

- A1 - Auxiliary Battery
- G40 - Camshaft Position (CMP) Sensor
- J65 - Heater Control Module, in intake channel
- J372 - Circuit board for temperature sensor, control module for blower motor and glow plug
- Q6 - Glow plug, in heater unit
- T1 - Single Connector
- T4 - 4-Pin Connector
- T4a - 4-Pin Connector
- T12 - 12-Pin Conenctor
- T12a - 12-Pin Conenctor
- T12c - 12-Pin Conenctor, to intake channel
- V81 - Fresh Air/Heater blower, in heater unit

(253) - Ground connection, in wiring harness heater unit

(189) - Ground connection -1-, in heater wiring harness

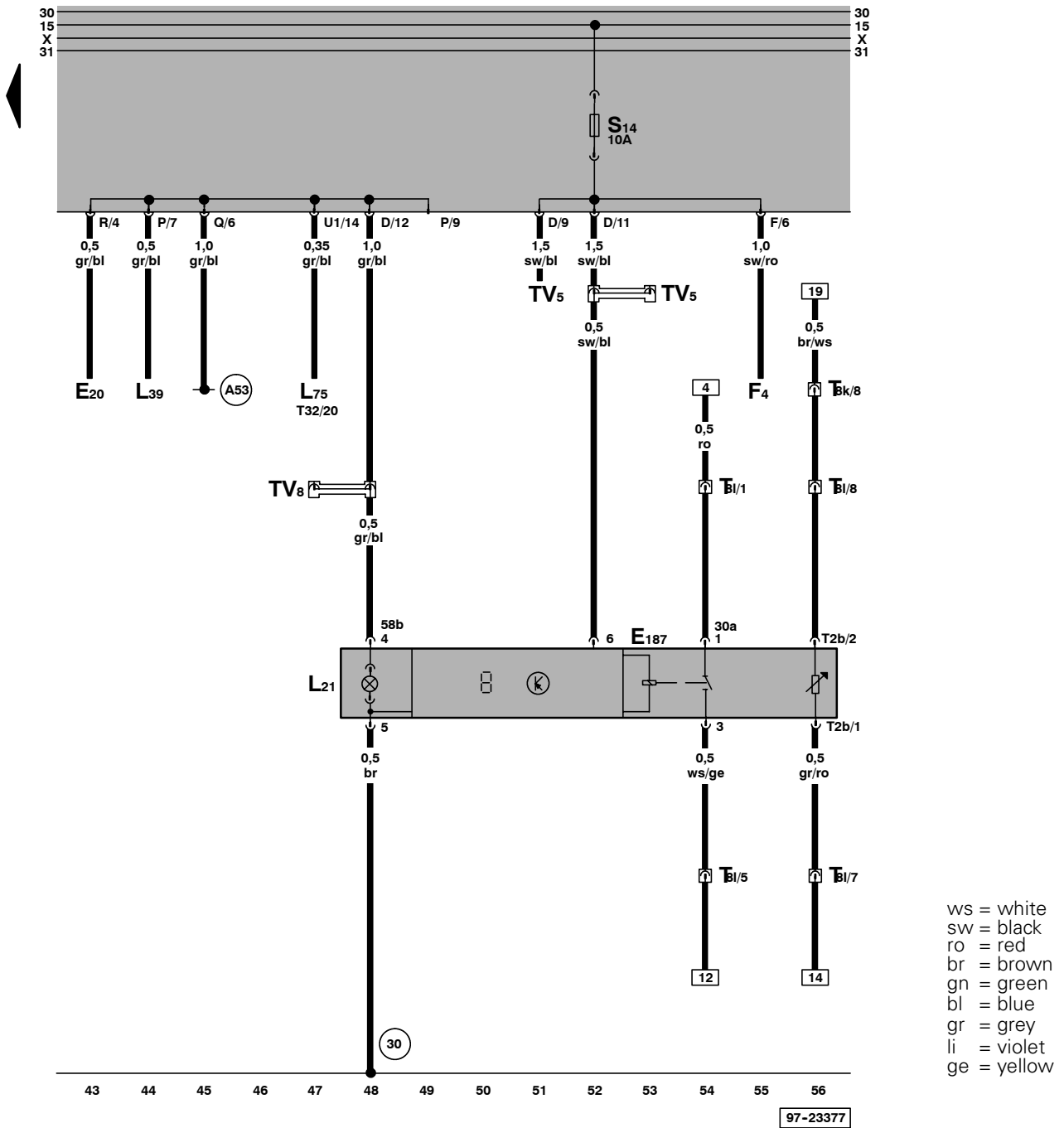

- E20 - Instrument Panel Light Dimmer Switch
- E187 - Programable timer with temperature control
- F4 - Back-Up Light Switch
- L21 - Heater Control Lever Light
- L39 - Rear Window Defogger Switch Light
- L75 - Digital Display Light
- T2b - Double Connector
- T8k - 8-Pin Connector, below driver's seat
- T8l - 8-Pin Connector, behind fuse/relay panel
- T32 - 32-Pin Connector, blue, on instrument cluster
- TV5 - Terminal 15a Wire Connector, green, 4-Pin and 8-Pin
- TV8 - Terminal 58b Wire Connector, grey
- (30) - Ground connection, -1-, beside fuse/relay panel

(A53) - Plus connection (58b), in instrument panel wiring harness